

Instruction Manual

HI 9142

Portable Waterproof Dissolved Oxygen Meter

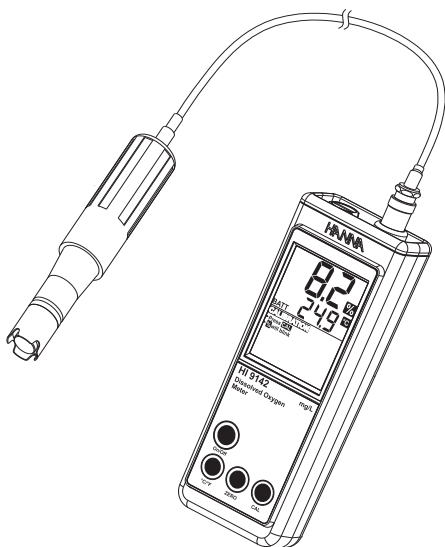

www.hannainst.com

Dear Customer,

Thank you for choosing a Hanna Instruments Product.

Please read this instruction manual carefully before using the instrument.

This manual will provide you with all the necessary information for correct use of the instrument, as well as a precise idea of its versatility.

If you need additional technical information, do not hesitate to e-mail us at tech@hannainst.com or view our worldwide contact list at www.hannainst.com.

TABLE OF CONTENTS

PRELIMINARY EXAMINATION	3
GENERAL DESCRIPTION	3
PROBE FUNCTIONAL DESCRIPTION	4
METER FUNCTIONAL DESCRIPTION	5
SPECIFICATIONS	6
PROBE INITIAL PREPARATION	7
CALIBRATION PROCEDURE	9
TAKING MEASUREMENTS	11
ALTITUDE AND SALINITY COMPENSATION	12
PROBE AND MEMBRANE MAINTENANCE	14
BATTERY REPLACEMENT	16
ACCESSORIES	17
WARRANTY	18

PRELIMINARY EXAMINATION

Remove the instrument from the packing material and examine it to make sure that no damage has occurred during shipping. If there is any damage, notify your Dealer.

The meter is supplied complete with:

- **HI 76407/4** DO probe with 4 m cable
- 2 spare membranes with O-rings
- **HI 7041S** electrolyte solution (30 mL)
- Calibration screwdriver
- Batteries (3 x 1.5V AAA)
- Instruction manual
- Rugged carrying case

Note: Save all packing material until you are sure that the instrument functions correctly. All defective items must be returned to us in the original packaging with the supplied accessories.

GENERAL DESCRIPTION

HI 9142 is a rugged, waterproof meter that solves the common problems of field use, such as cold, rain, snow and dust, that can damage a meter, rapidly deteriorating its performance and life. It is very simple to use: calibration is performed with **HI 7040** zero oxygen solution, while 100% calibration is done in air.

The polarographic probe (**HI 76407/4**) is provided with a membrane covering the sensors and a built-in thermistor for temperature measurement and compensation. The thin permeable membrane isolates the sensor elements from the testing solution, but allows oxygen to enter. When a voltage is applied across the sensor, oxygen that has passed through the membrane reacts causing current to flow, allowing the determination of oxygen. The probe included with the meter is supplied with a 4 m (13') cable that allows measurements to be taken even in even hard to reach places. For applications that require longer probe cables, the **HI 76407/10** and **HI 76407/20** probes with a 10 m (33') or 20 m (67') cable are available.

PROBE FUNCTIONAL DESCRIPTION

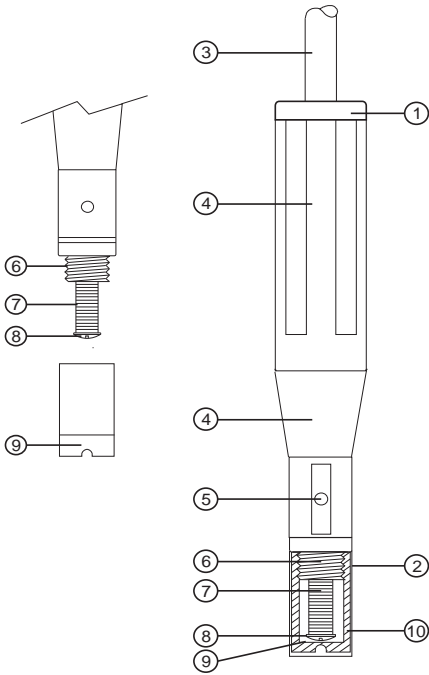

1. D.O. probe
2. Protective cap
3. Shielded cable
4. Polypropylene probe body
5. Temperature sensor
6. O-Ring seal
7. Silver chloride (AgCl) anode
8. Platinum cathode (sensor)
9. Oxygen permeable membrane
10. Membrane cap

METER FUNCTIONAL DESCRIPTION

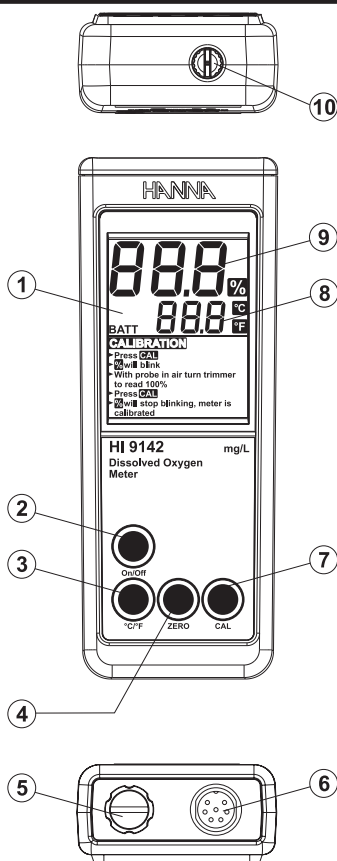

1. Liquid Crystal Display (LCD)
2. **On/Off** button
3. °C/°F Celsius or Fahrenheit selection button
4. Zero oxygen calibration button
5. Battery compartment cap
6. Probe connector (DIN7)
7. Calibration button
8. Secondary LCD line
9. Primary LCD line
10. Slope calibration trimmer

SPECIFICATIONS

Range	0.0 to 19.9 mg/L (ppm) -5.0 to 50.0°C (23.0 to 122.0°F)
Resolution	0.1 mg/L 0.1°C (1°F)
Accuracy	±1.5% FS ±0.2°C (±1°F) excluding probe error
Calibration	Manual in 100% DO Automatic in 0% DO
Temperature Compensation	Automatic, 0 to 50°C (32 to 122°F)
Probe	HI 76407/4, polarographic, with 4 m (13') cable (included)
Battery Type	3 x 1.5V AAA
Life	approx. 1000 hours of use
Auto-off	After approx. 8 minutes
Environment	0 to 50°C (32 to 122°F); RH max 100%
Dimensions	185 x 72 x 36 mm (7.3 x 2.8 x 1.4")
Weight	300 g (10.6 oz.)

PROBE INITIAL PREPARATION

Probe Preparation

All D.O. probes from Hanna Instrument are shipped dry. To hydrate the probe and prepare it for use, connect it to the meter and proceed as follows.

1. Remove the red & black plastic cap. This cap is used for shipping purposes only and can be thrown away.
2. Wet the sensor by soaking the bottom (2.5 cm/1") of the probe in HI 7041S electrolyte solution for 5 minutes.

Shipping cap



3. Rinse the membrane (HI 76407A supplied with the meter) with some electrolyte while shaking it gently. Refill with clean electrolyte.

4. Gently tap the sides of the membrane with your finger to ensure that no air bubbles remain trapped inside.

FILL FIRST

THEN TAP

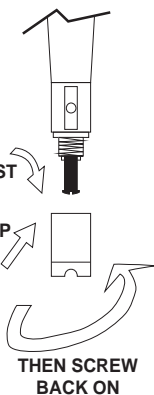

To avoid damaging the membrane, do not tap the membrane directly on the bottom.

5. Place the rubber O-Ring properly inside the membrane cap.
6. With the sensor facing down, screw the cap clockwise. Some electrolyte will overflow.

When not in use and during polarization, protect the membrane with the supplied cap.

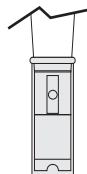

Connect the probe to the instrument.
Turn the instrument ON by pressing
On/Off.



At start-up the display will show all the used segments for a few seconds followed by the percentage indication of the remaining battery life.

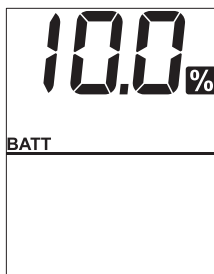
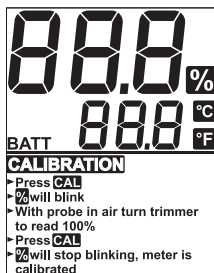

- After a few seconds “Cnd Prb” message appears, to inform the user that the probe is in auto-conditioning mode (automatic polarization, about 1 minute).

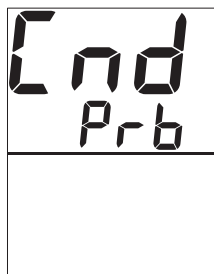

Note: Press any key (except **On/Off**) to skip conditioning time.

- When the conditioning message disappears, the probe is polarized and the instrument can be calibrated.
- The meter is now ready to operate.

If the probe is not connected, the display shows “---” on both LCD lines.

The auto-off feature turns the instrument off after about 8 min, if no key is pressed.

PROBE POLARIZATION

The probe is under polarization with a fixed voltage of approximately 800 mV.

Probe polarization is essential for stable measurements with the same recurring degree of accuracy.

With the probe properly polarized, oxygen is continually “consumed” by passing through the sensitive diaphragm and dissolving in the electrolyte solution contained in the probe.

If this operation is interrupted, the electrolyte solution continues to be enriched with oxygen until it reaches an equilibrium with the surrounding solution.

Whenever measurements are taken with a non-polarized probe, the oxygen level revealed are both that of the tested solution as well of the electrolyte solution. This reading is incorrect.

CALIBRATION PROCEDURE

The calibration is very simple and fast.

- Make sure the probe is ready for measurements (see initial preparation at page 7), i.e. the membrane is filled with electrolyte and the probe is connected to the meter.
- Switch the meter on by pressing the **On/Off** key.
- For an accurate calibration, it is recommended that you wait at least 15 minutes to ensure precise conditioning of the probe.
- Remove the protective cap from the D.O. probe.

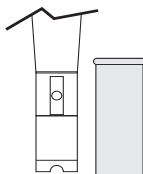

SLOPE CALIBRATION

It is suggested to perform the slope calibration in saturated air (100% DO).

- Rinse the probe in a large amount of clean water to remove any residual zero oxygen solution.

Dry the probe tip and allow a few minutes for the LCD readout to stabilize.

- Press the **CAL** key and follow the indication on the display.
- Adjust the slope trimmer on the bottom of the meter to read "100%" on the LCD.



Note:

- The slope calibration screw is located on the bottom of the case.
- Press the **CAL** key and the LCD will display the value in mg/L of oxygen.



A **zero calibration** is also possible.

ZERO CALIBRATION

- Dip the probe into **HI 7040** zero oxygen solution and stir gently for 2-3 minutes.
- Press and hold down **CAL** key then press **ZERO** key.
- % tag will blink until the reading stabilize.
- When the reading is stable, the message "Press **CAL**,, meter is calibrated" will be displayed.
- Press **CAL** to exit zero calibration.



The **zero calibration** of the **HI 9142** is very stable, therefore this procedure needs only to be performed **whenever the probe is replaced**.

However, because the **slope calibration** is more critical, it is **recommended to perform this procedure every week**.

TAKING MEASUREMENTS

Make sure the meter has been calibrated and the protective cap has been removed. Immerse the tip of the probe in the sample to be tested.



Make sure the temperature sensor is also immersed.

For accurate dissolved oxygen measurements a water movement of 0.3 m/sec is required at a minimum. This is to ensure that the oxygen-depleted membrane surface is constantly replenished. A moving stream will provide adequate circulation. To quickly check if the water speed is sufficient, wait for the reading to stabilize and then move the D.O. probe. If the reading is still stable, the measurement conditions are right, while if the reading increases the water movement is not adequate.

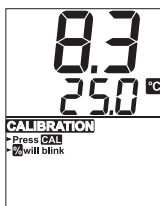

During field measurements, this condition may be met by manually agitating the probe. Accurate readings are not possible while the liquid is at rest.

During laboratory measurements, the use of a magnetic stirrer to ensure a certain velocity in the fluid is recommended. In this way, errors due to the diffusion of the oxygen present in the air in the solution are reduced to a minimum.

At all times, time necessary for thermal equilibrium to occur between the probe and the sample must be allowed (a few minutes for temperature difference of several degrees).

ALTITUDE AND SALINITY COMPENSATION

If the sample contains salts or if you are performing the measurements at a different altitude than sea level, the readout values must be corrected, taking into account the lower degree of oxygen solubility.

ALTITUDE COMPENSATION

All the readouts are referred at sea level, thus the displayed measurements are higher than the actual values. In fact, altitude affects D.O. concentration decreasing its value. The following table reports the oxygen solubility at various temperatures and altitudes, based on sea level barometric pressure of 760 mm Hg.

°C	Altitude, Meters above Sea Level							°F
	0 m	300 m	600 m	900 m	1200 m	1500 m	1800 m	
0	14.6	14.1	13.6	13.2	12.7	12.3	11.8	32.0
2	13.8	13.3	12.9	12.4	12.0	11.6	11.2	35.6
4	13.1	12.7	12.2	11.9	11.4	11.0	10.6	39.2
6	12.4	12.0	11.6	11.2	10.8	10.4	10.1	42.8
8	11.8	11.4	11.0	10.6	10.3	9.9	9.6	46.4
10	11.3	10.9	10.5	10.2	9.8	9.5	9.2	50.0
12	10.8	10.4	10.1	9.7	9.4	9.1	8.8	53.6
14	10.3	9.9	9.6	9.3	9.0	8.7	8.3	57.2
16	9.9	9.7	9.2	8.9	8.6	8.3	8.0	60.8
18	9.5	9.2	8.7	8.6	8.3	8.0	7.7	64.4
20	9.1	8.8	8.5	8.2	7.9	7.7	7.4	68.0
22	8.7	8.4	8.1	7.8	7.7	7.3	7.1	71.6
24	8.4	8.1	7.8	7.5	7.3	7.1	6.8	75.2
26	8.1	7.8	7.5	7.3	7.0	6.8	6.6	78.8
28	7.8	7.5	7.3	7.0	6.8	6.6	6.3	82.4
30	7.5	7.2	7.0	6.8	6.5	6.3	6.1	86.0
32	7.3	7.1	6.8	6.6	6.4	6.1	5.9	89.6
34	7.1	6.9	6.6	6.4	6.2	6.0	5.8	93.2
36	6.8	6.6	6.3	6.1	5.9	5.7	5.5	96.8
38	6.6	6.4	6.2	5.9	5.7	5.6	5.4	100.4
40	6.4	6.2	6.0	5.8	5.6	5.4	5.2	104.4

This gives an idea of the error that can be introduced at different altitudes and allows you to calculate the quantity to be subtracted to correct your reading.

SALINITY COMPENSATION

The table below shows the influence of salt in the measurement of oxygen.

In **HI 9142** all the readouts are referred to 0 g/L of salinity value. In fact, salinity affects D.O. concentration decreasing its value.

For your reference the table below reports the oxygen solubility at various temperatures and salinity. From the table you can calculate the quantity to be subtracted to correct your reading.

°C	Salinity (g/L) at Sea Level					°F
	0 g/L	10 g/L	20 g/L	30 g/L	35 g/L	
10	11.3	10.6	9.9	9.3	9.0	50.0
12	10.8	10.1	9.5	8.9	8.6	53.6
14	10.3	9.7	9.1	8.6	8.3	57.2
16	9.9	9.3	8.7	8.2	8.0	60.8
18	9.5	8.9	8.4	7.9	7.6	64.4
20	9.1	8.5	8.0	7.6	7.4	68.0
22	8.7	8.2	7.8	7.3	7.1	71.6
24	8.4	7.9	7.5	7.1	6.9	75.2
26	8.1	7.6	7.2	6.8	6.6	78.8
28	7.8	7.4	7.0	6.6	6.4	82.4

PROBE AND MEMBRANE MAINTENANCE

The oxygen probe body is made of reinforced plastic for maximum durability.

A thermistor temperature sensor provides temperature measurement and compensation. When not in use, it is always recommended to protect the probe against damage and dirt using the supplied cap.

To replace the membrane or refill with electrolyte, proceed as follows:

- Remove the protective cap by gently twisting and pulling it off (see fig. 1).
- Unscrew the membrane by turning it counterclockwise (see fig. 2).
- Wet the sensor by soaking the bottom (2.5 cm) of the probe in **HI 7041S** electrolyte solution for 5 minutes.
- Rinse the new membrane (**HI 76407A** supplied with the meter) with some electrolyte while shaking it gently. Refill with clean electrolyte.
- Gently tap the sides of the membrane with your finger to ensure that no air bubbles remain trapped inside. Do not directly tap the bottom as this will damage the membrane.
- Make sure that the rubber O-ring is seated properly inside the membrane cap.
- With the sensor facing down, screw the membrane cap clockwise. Some electrolyte will overflow.

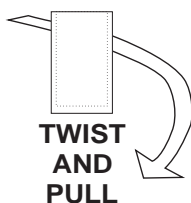

fig. 1

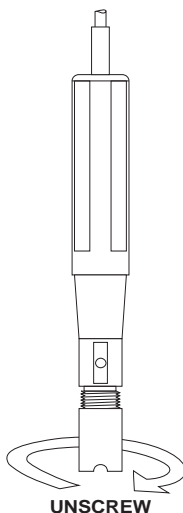

fig. 2

The Platinum cathode (#8 in the Functional Description at page 4) should always be bright and untarnished. If it is tarnished or stained, which could be due to contact with certain gases or extended use with a loose or damaged membrane, the cathode should be cleaned. Use a lint-free cardboard or cloth and rub the cathode very gently side to side 4-5 times. This will be enough to polish and remove any stains without damaging the platinum tip. Afterwards, rinse the probe with deionized or distilled water and install a new membrane cap using fresh electrolyte. Recalibrate the instrument.

Important: In order to have accurate and stable measurements, it is important that the surface of the membrane is in perfect condition. This semi-permeable membrane isolates the sensor elements from the environment but allows oxygen to enter. If any dirt is observed on the membrane, rinse carefully with distilled or deionized water. If any imperfection still exists, or any damage is evident (such as wrinkles or tears), the membrane should be replaced. Make sure that the O-Ring is properly seated in the membrane cap.

BATTERY REPLACEMENT

When the battery level is low, “BATT” tag is displayed blinking on the LCD to advise the user that approx. 1 hour of working time is left.

It is recommended to change the batteries as soon as the battery indicator blinks.

To replace the batteries, follow the next steps:

- Turn OFF the instrument.
- Open the battery compartment cap (located on the top of the instrument).
- Remove old batteries.
- Insert three new 1.5V AAA batteries in the battery compartment, following the instructions on the rear of the instrument.
- Reattach the battery compartment cap.

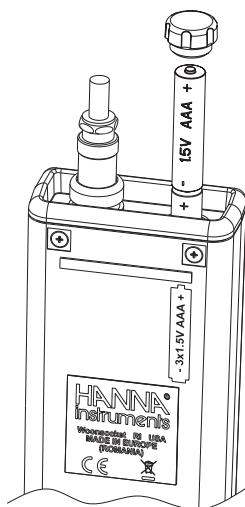

The instrument is provided with the BEPS (Battery Error Prevention System) feature, which automatically turns the instrument off when the batteries level is too low to ensure reliable readings.

At start up the display will show “0 % BATT” message for a few seconds, then the instrument automatically turns off.

ACCESSORIES

HI 7040L	Zero oxygen solution, 500 mL
HI 7041S	Refilling electrolyte solution, 30 mL
HI 7041M	Refilling electrolyte solution, 230 mL
HI 7041L	Refilling electrolyte solution, 500 mL
HI 76407/4	D.O. probe with 4 m (13') cable
HI 76407/10	D.O. probe with 10 m (33') cable
HI 76407/20	D.O. probe with 20 m (66') cable
HI 76407A/P	D.O. membrane (5 pcs)

WARRANTY

HI 9142 is guaranteed for two years against defects in workmanship and materials when used for their intended purpose and maintained according to instructions. Electrodes and probes are guaranteed for six months. This warranty is limited to repair or replacement free of charge.

Damage due to accidents, misuse, tampering or lack of prescribed maintenance is not covered.

If service is required, contact the dealer from whom you purchased the instrument. If under warranty, report the model number, date of purchase, serial number and the nature of the problem. If the repair is not covered by the warranty, you will be notified of the charges incurred. If the instrument is to be returned to Hanna Instruments, first obtain a Returned Goods Authorization number from the Technical Service department and then send it with shipping costs prepaid. When shipping any instrument, make sure it is properly packed for complete protection.

All rights are reserved. Reproduction in whole or in part is prohibited without the written consent of the copyright owner.

Recommendations for Users

Before using this product, make sure that it is entirely suitable for the environment in which it is used.

Operation of this instrument in residential area could cause unacceptable interferences to radio and TV equipment, requiring the operator to take all necessary steps to correct interferences.

Any variation introduced by the user to the supplied equipment may degrade the instrument's EMC performance.

To avoid electrical shock, do not use this instrument when voltages at the measurement surface exceed 24 Vac or 60 Vdc.

To avoid damages or burns, do not perform any measurement in microwave ovens.

In particular cases the meter could turn off. In these cases it can be turned on by pressing the ON/OFF key.

Hanna Instruments reserves the right to modify the design, construction or appearance of its products without advance notice.



Hanna Instruments Inc.
Highland Industrial Park
584 Park East Drive
Woonsocket, RI 02895 USA

Technical Support for Customers

Tel. (800) 426 6287
Fax (401) 765 7575
E-mail tech@hannainst.com
www.hannainst.com

Local Sales and Customer Service Office

